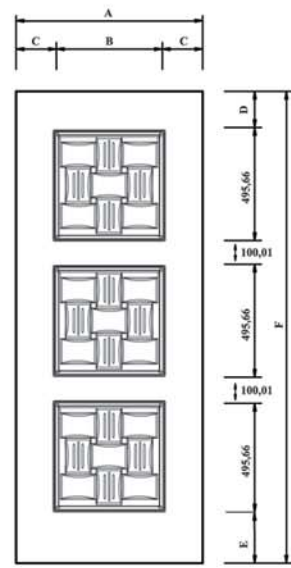
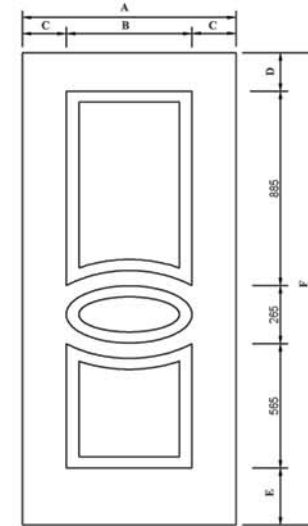

ILGAZ PV-09

KANAT ENİ	MODEL ENİ	SEREN PAYI
WING WIDTH	DESIGN WIDTH	SPAR DISTANCE
A (mm)	B (mm)	C (mm)
850	500	175
920	570	175
D (mm)	E (mm)	F (mm)
183	280	2150

Yüzey /Surface : Çam/ Pine
Kalınlık /Thickness: 3.2 mm

**TÜRKİYE'NİN
YENİ KAPI
PANELİ****YENİ
NEW****HAZAR PV-11**

KANAT ENİ	MODEL ENİ	SEREN PAYI
WING WIDTH	DESIGN WIDTH	SPAR DISTANCE
A (mm)	B (mm)	C (mm)
850	500	175
920	500	210
D (mm)	E (mm)	F (mm)
175	260	2150

Yüzey /Surface : Freze
Kalınlık /Thickness: 3.2 mm

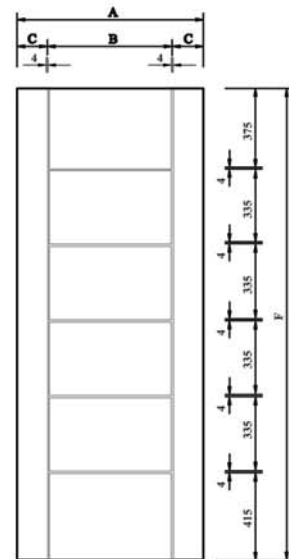
**MADRA PV-10**

KANAT ENİ	MODEL ENİ	SEREN PAYI
WING WIDTH	DESIGN WIDTH	SPAR DISTANCE
A (mm)	B (mm)	C (mm)
850	500	175
920	570	175
D (mm)	E (mm)	F (mm)
375	415	2150

Yüzey /Surface : Çam/ Pine
Kalınlık /Thickness: 3.2 mm



Baskı Tarihi: Ağustos 2012

vario panel®**vario panel®****DOOR SKIN - KAPI PANELİ**

Çizgisiyle mekanlara şıklık katar!



YILDIZ ENTEGRE A.Ş.



www.vario.com.tr

Arslanbey O.S.B. Mah. 1. Cadde No: 13 41285 Kartepe / Kocaeli / Türkiye
• Tel: +90 262 316 61 00 - 316 62 00 (ISDN) • Faks: +90 262 316 61 94 (6HAT) 316 62 21 - 22

TOROS PV-01

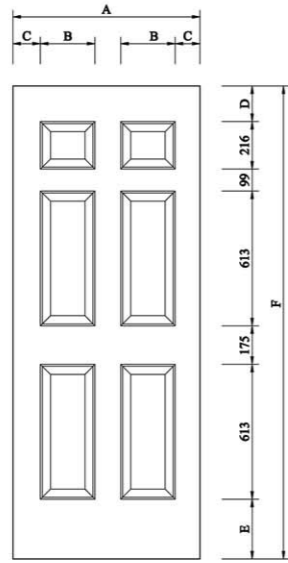

KANAT ENİ	MODEL ENİ	SEREN PAYI
WING WIDTH	DESIGN WIDTH	SPAR DISTANCE
A (mm)	B (mm)	C (mm)
670	149x2	137
780	201x2	140
850	251x2	125
920	274x2	137
1030	280x2	186

D (mm)	E (mm)	F (mm)
162	272	2150

Yüzey /Surface : Çam/ Pine
Kalınlık /Thickness: 3.2 mm

ZİGANA PV-02

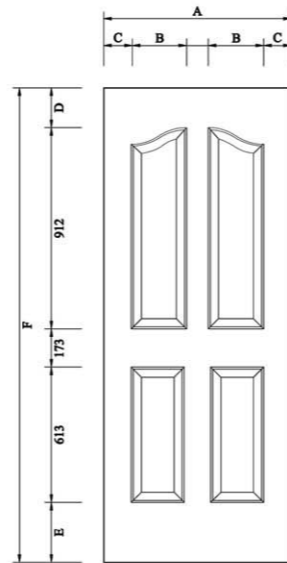

KANAT ENİ	MODEL ENİ	SEREN PAYI
WING WIDTH	DESIGN WIDTH	SPAR DISTANCE
A (mm)	B (mm)	C (mm)
670	149x2	137
780	201x2	140
850	251x2	125
920	274x2	137
1030	280x2	190

D (mm)	E (mm)	F (mm)
180	272	2150

Yüzey /Surface : Meşe/ Oak
Kalınlık /Thickness: 3.2 mm

CANIK PV-05

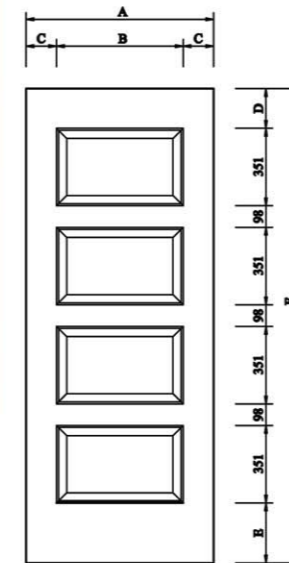

KANAT ENİ	MODEL ENİ	SEREN PAYI
WING WIDTH	DESIGN WIDTH	SPAR DISTANCE
A (mm)	B (mm)	C (mm)
780	524	128
850	574	138
920	624	148

D (mm)	E (mm)	F (mm)
180	272	2150

Yüzey /Surface : Freze
Kalınlık /Thickness: 3.2 mm

ERCİYES PV-06

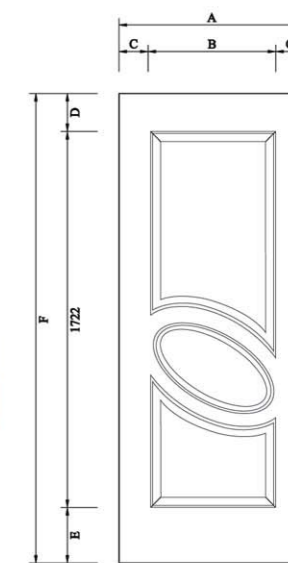

KANAT ENİ	MODEL ENİ	SEREN PAYI
WING WIDTH	DESIGN WIDTH	SPAR DISTANCE
A (mm)	B (mm)	C (mm)
780	500	140
850	600	125
920	640	140

D (mm)	E (mm)	F (mm)
174	254	2150

Yüzey /Surface : Meşe/ Oak
Kalınlık /Thickness: 3.2 mm

Not: Sol ve Sağ panel olmak üzere iki ayrı yönde üretilecektir. Yukarıdaki panel sol paneldir.
Not: Left and right profile will be produce with two different face. Left profile is located upper.

BOLU PV-03

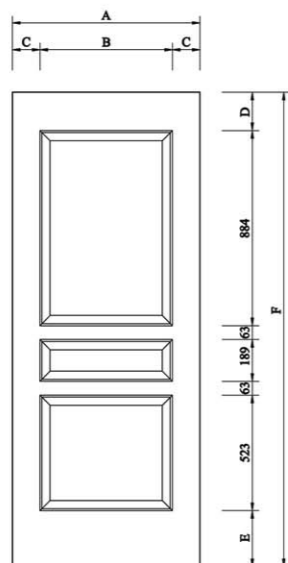

KANAT ENİ	MODEL ENİ	SEREN PAYI
WING WIDTH	DESIGN WIDTH	SPAR DISTANCE
A (mm)	B (mm)	C (mm)
670	400	135
780	500	140
850	600	125
920	694	113
1030	702	164

D (mm)	E (mm)	F (mm)
174	254	2150

Yüzey /Surface : Meşe/ Oak
Kalınlık /Thickness: 3.2 mm

ULUDAĞ PV-04

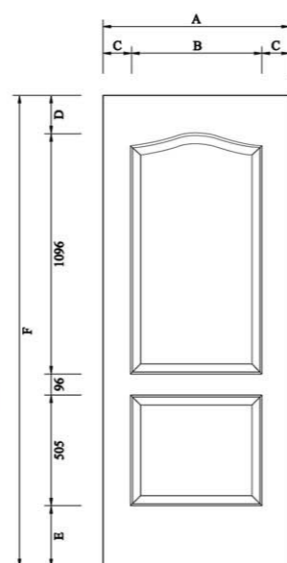

KANAT ENİ	MODEL ENİ	SEREN PAYI
WING WIDTH	DESIGN WIDTH	SPAR DISTANCE
A (mm)	B (mm)	C (mm)
670	380	145
780	500	140
850	580	135
920	634	143
1030	640	195

D (mm)	E (mm)	F (mm)
175	278	2150

Yüzey /Surface : Meşe/ Oak
Kalınlık /Thickness: 3.2 mm

KARTEPE PV-07

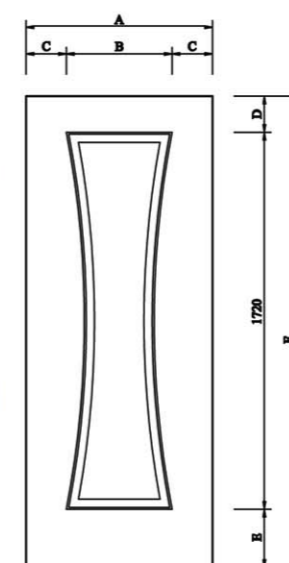

KANAT ENİ	MODEL ENİ	SEREN PAYI
WING WIDTH	DESIGN WIDTH	SPAR DISTANCE
A (mm)	B (mm)	C (mm)
670	452	109
780	482	149
850	482	184
920	482	219

D (mm)	E (mm)	F (mm)
165	265	2150

Yüzey /Surface : Çam/ Pine
Kalınlık /Thickness: 3.2 mm

AMANOS PV-08

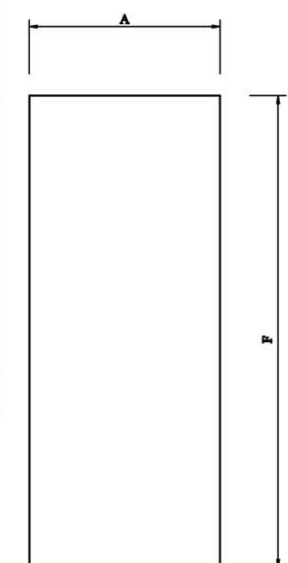

KANAT ENİ	MODEL ENİ	SEREN PAYI
WING WIDTH	DESIGN WIDTH	SPAR DISTANCE
A (mm)	B (mm)	C (mm)
670	Kasalık	
1700		

D (mm)	E (mm)	F (mm)
		2150

Yüzey /Surface : Meşe/ Oak
Kalınlık /Thickness: 3.2 mm